

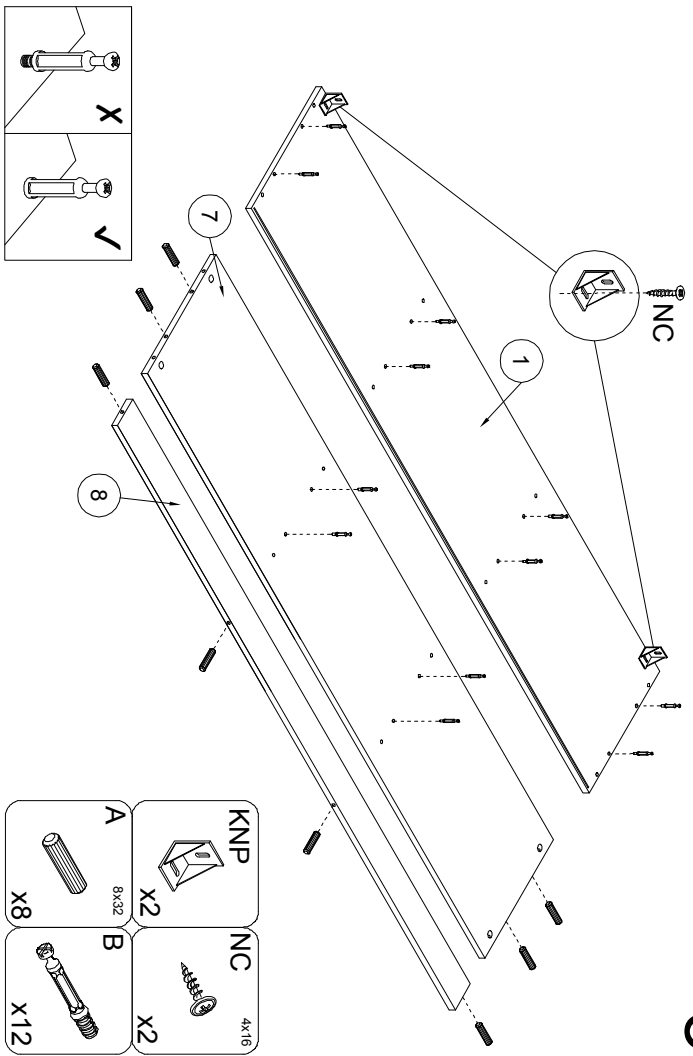

3

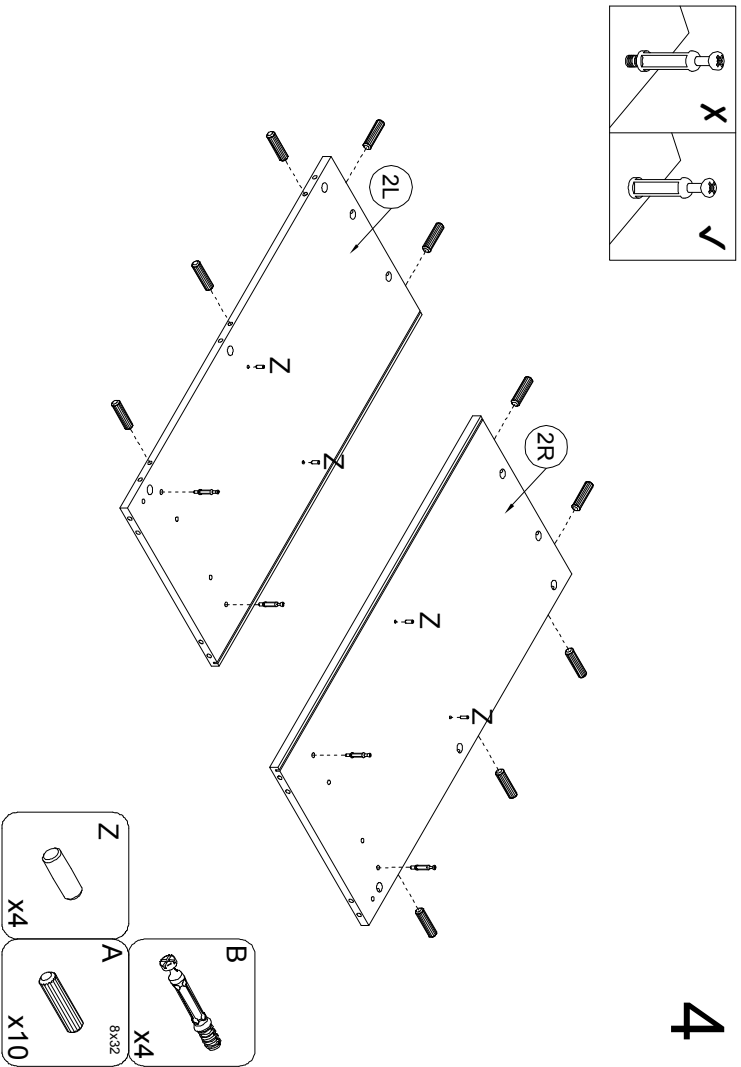

4



5

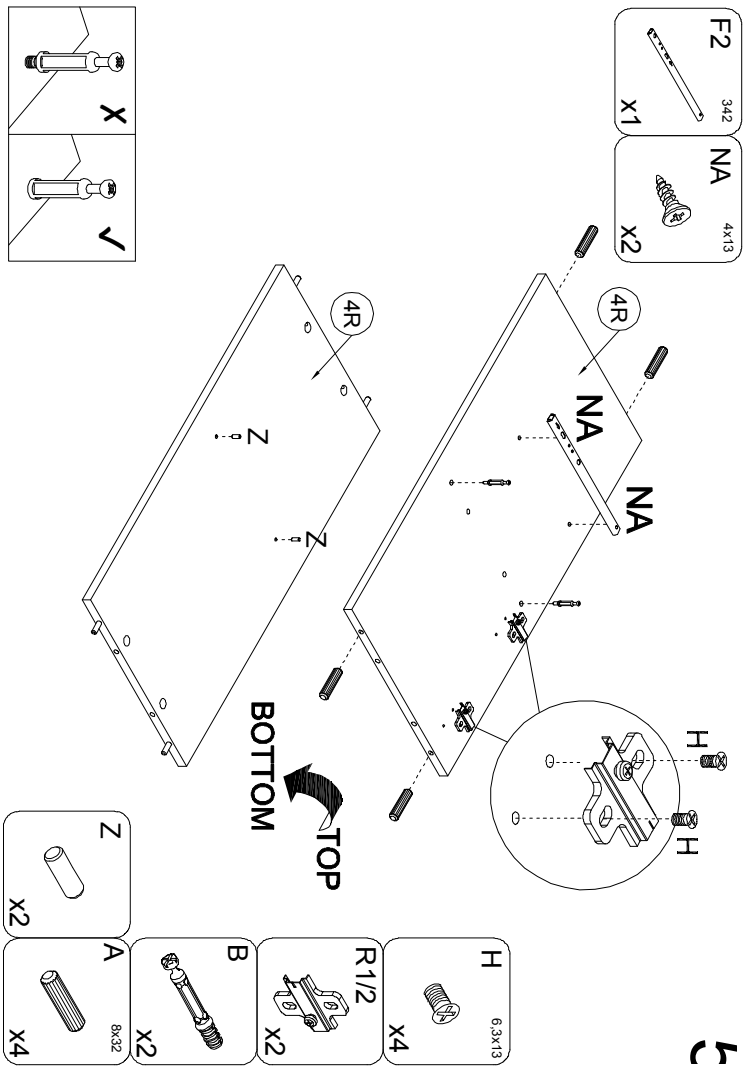

6

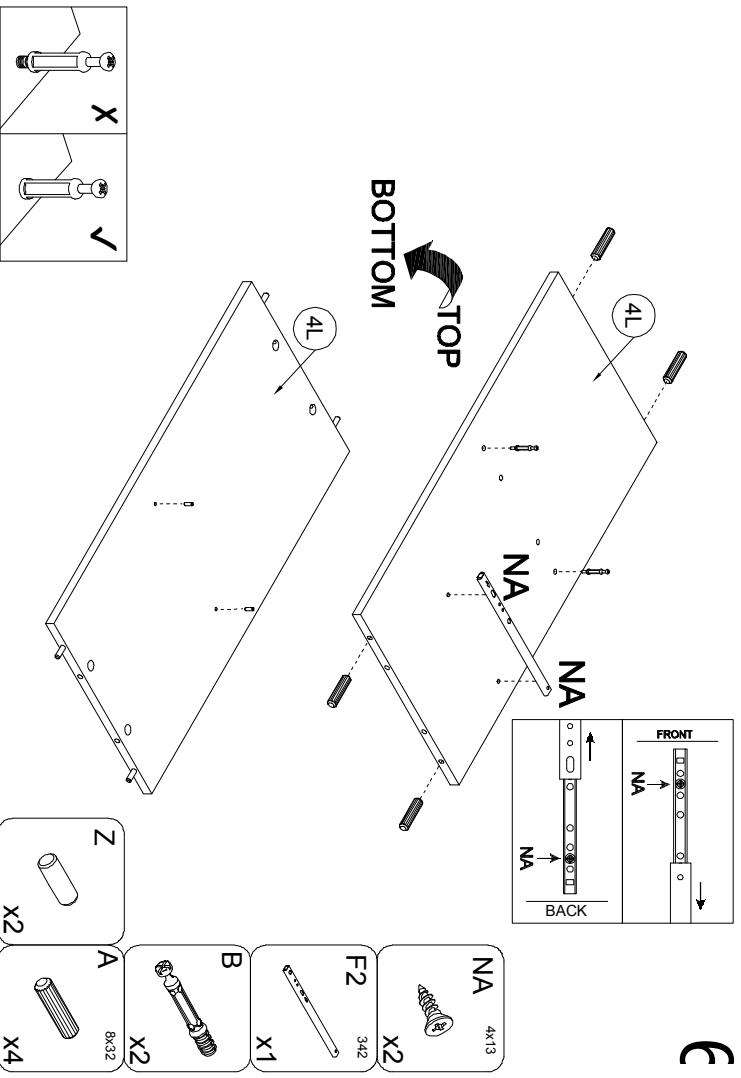

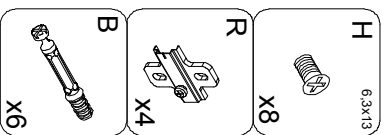
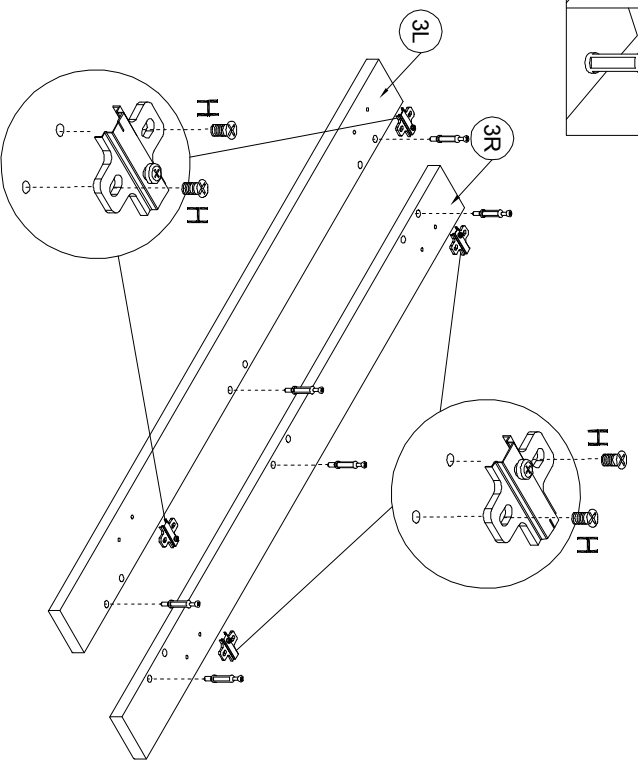
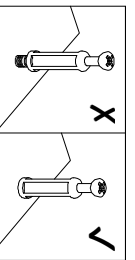

7

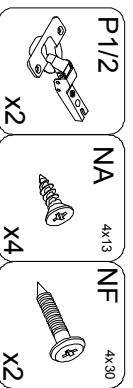
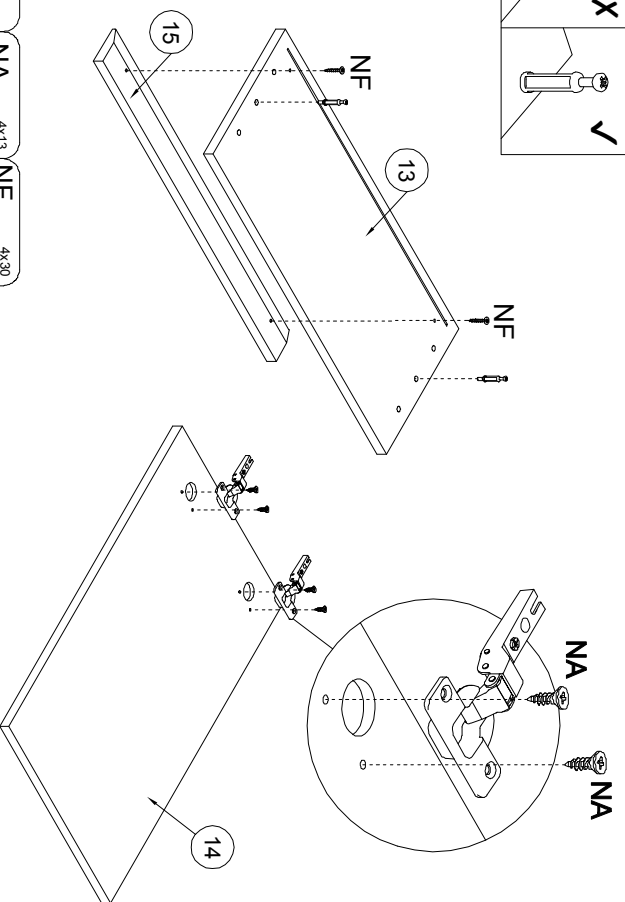
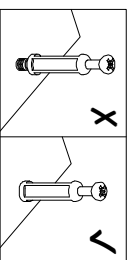

8

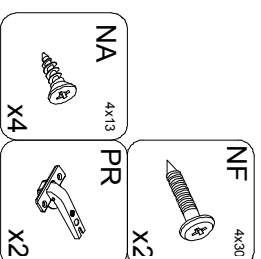
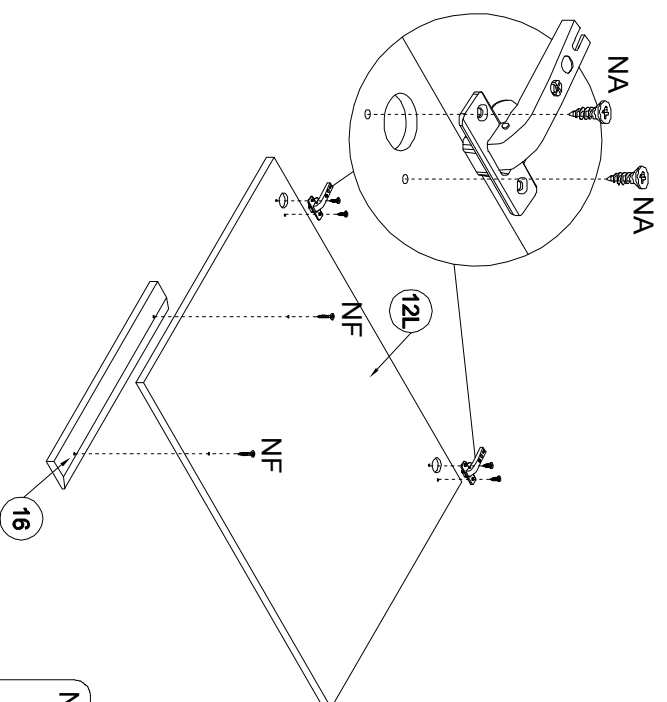

9

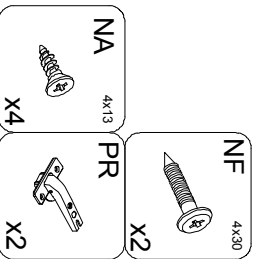
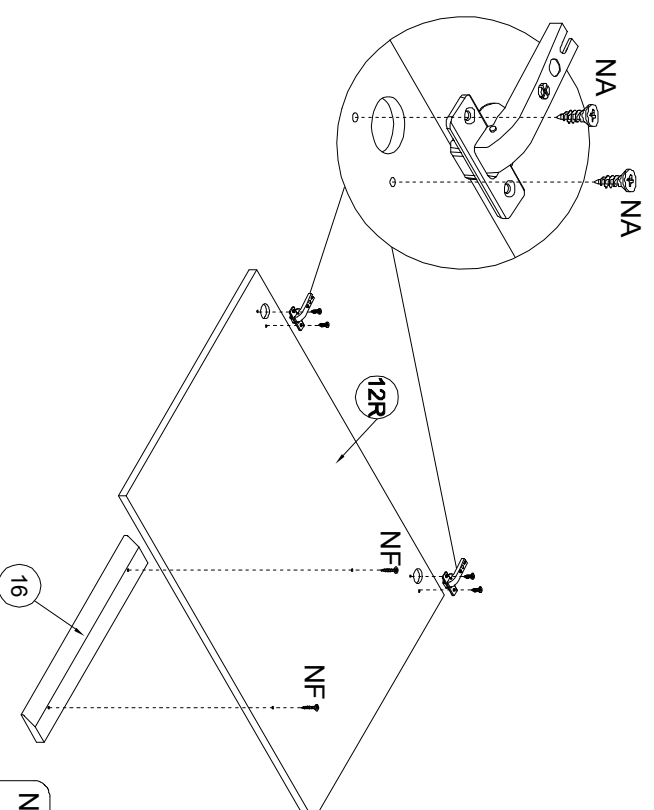

10

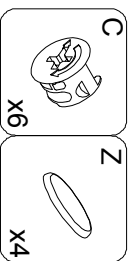
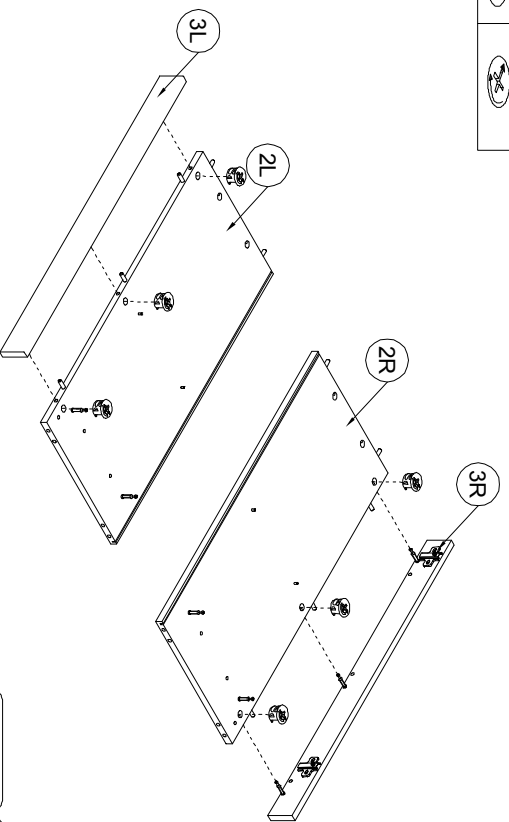
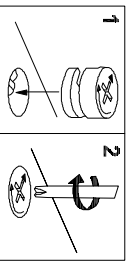

11

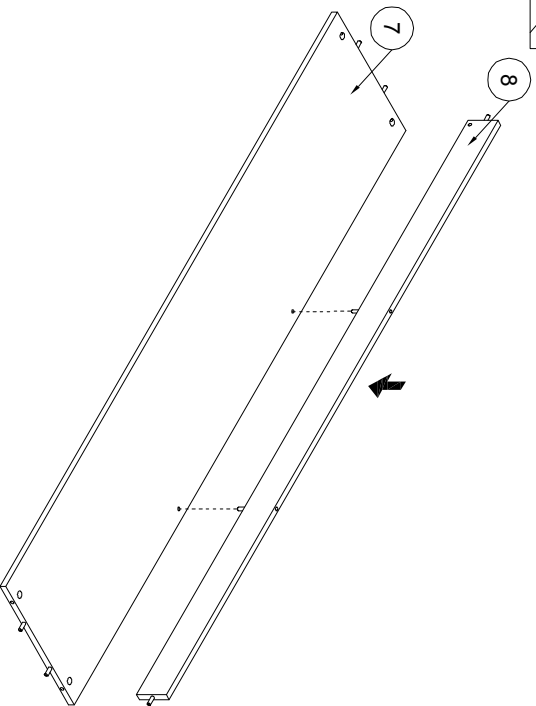
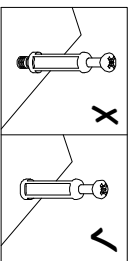

12

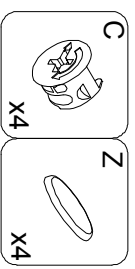
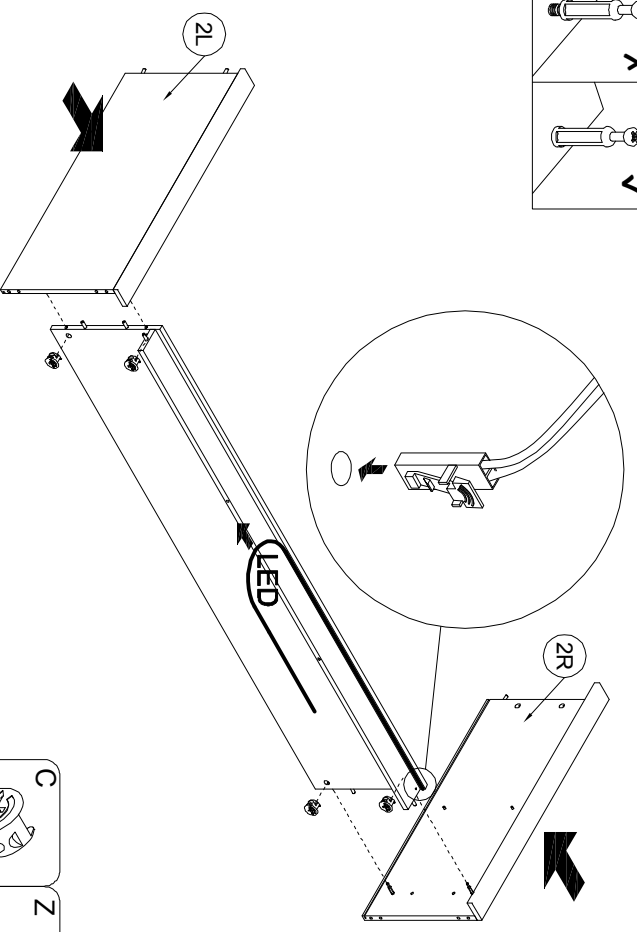
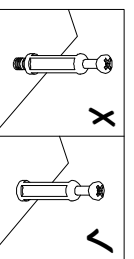

13

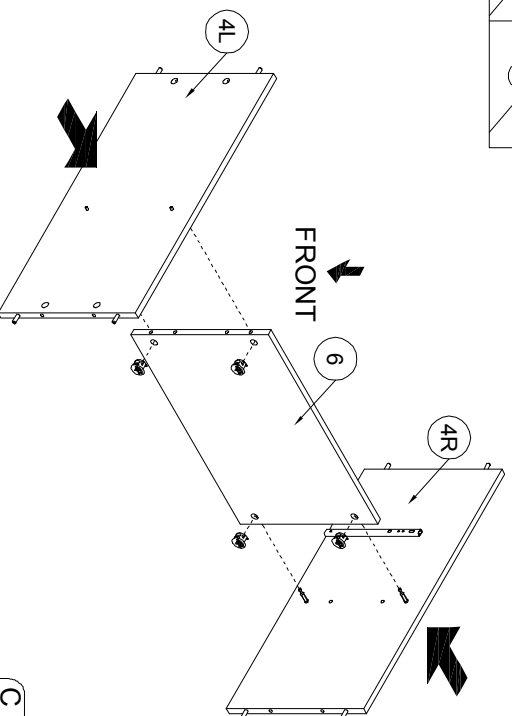
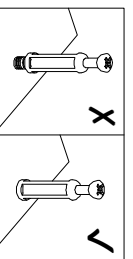

14



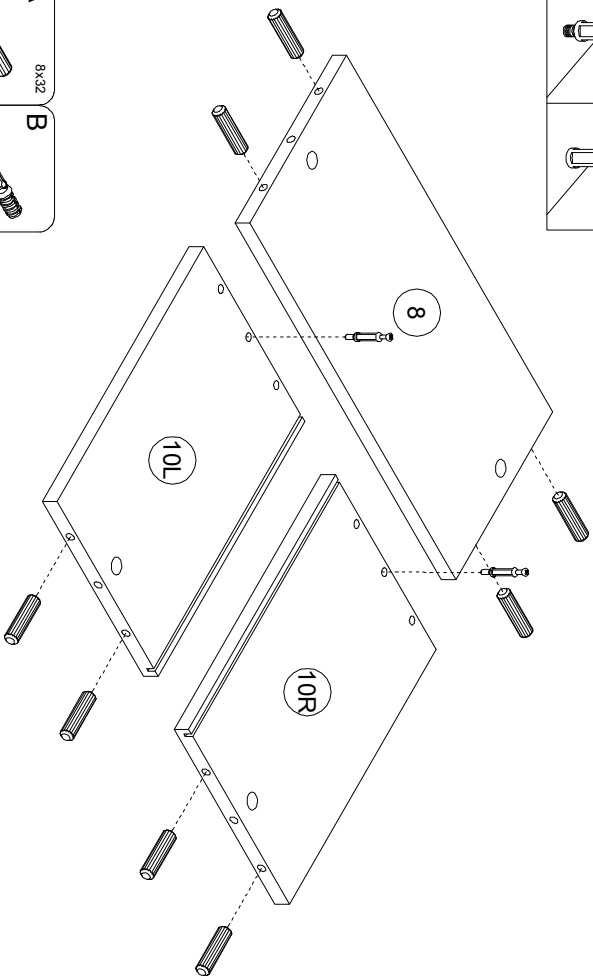
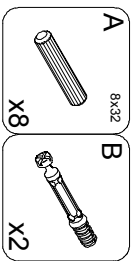
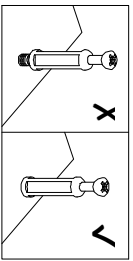

15

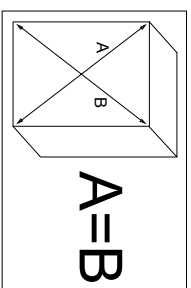
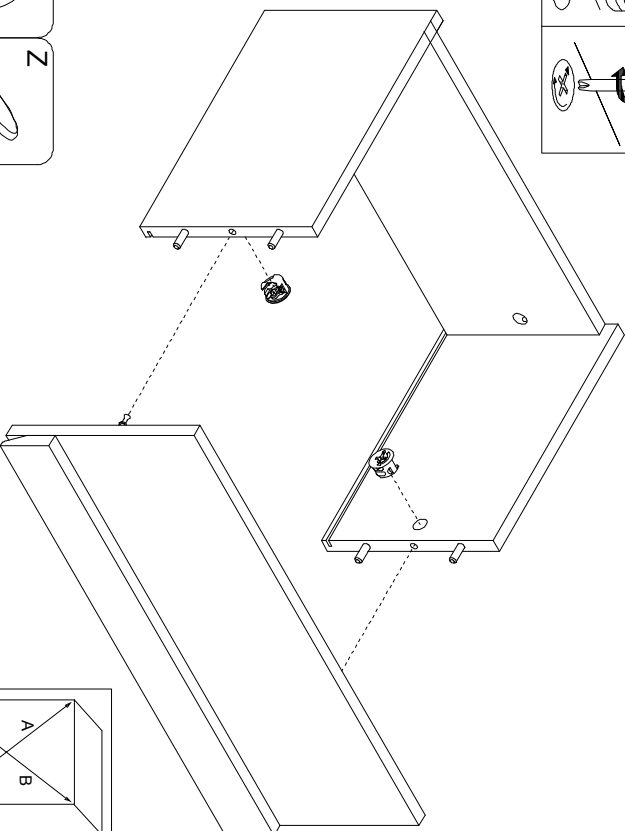
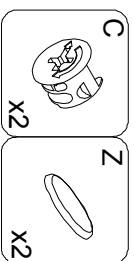
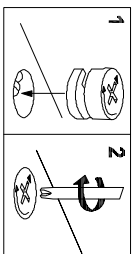

17

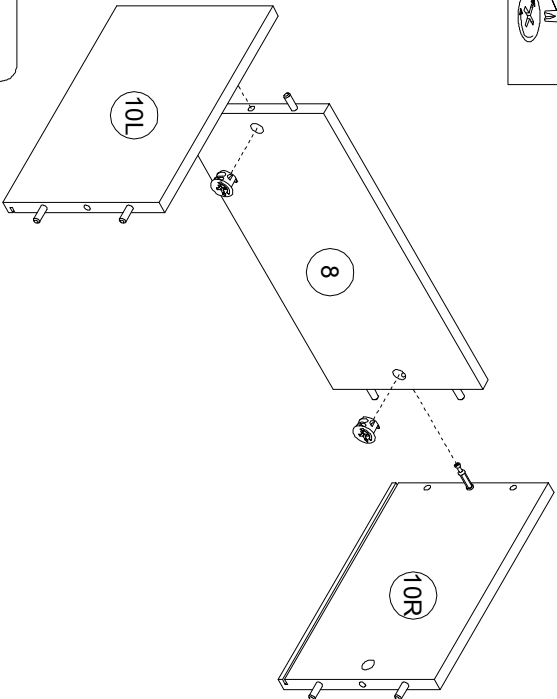
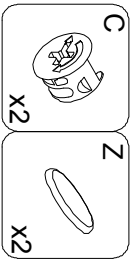
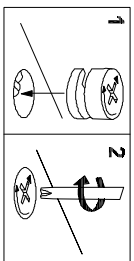

16

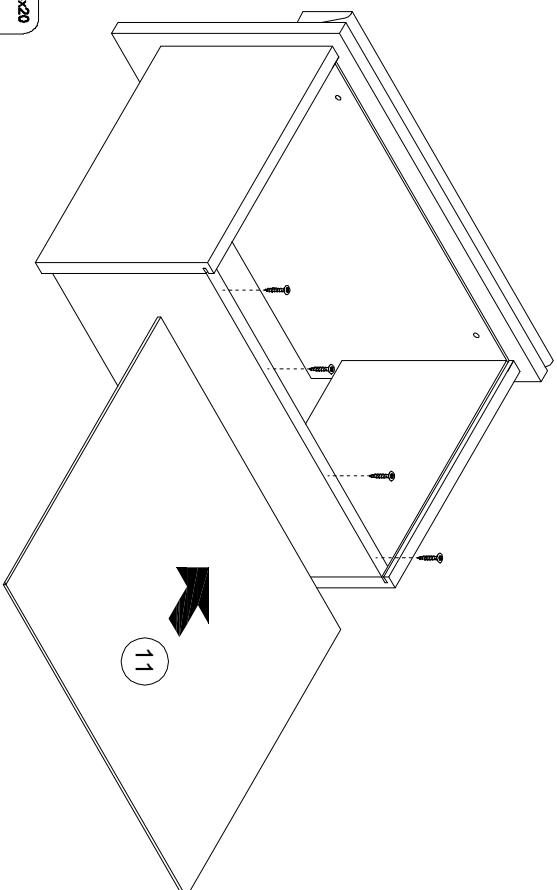
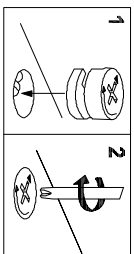

18

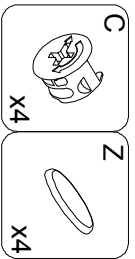
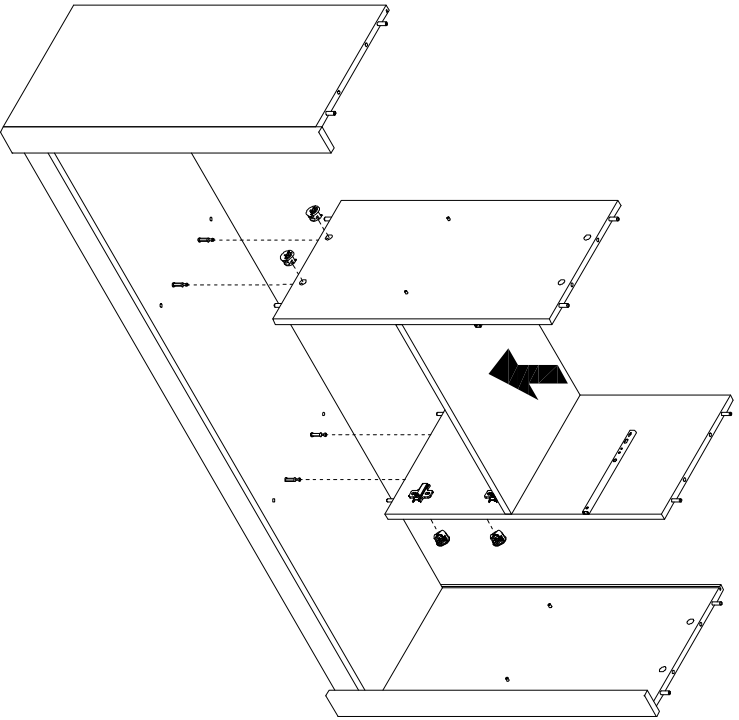
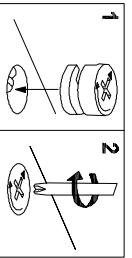

19

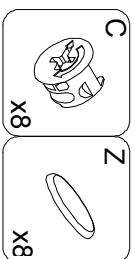
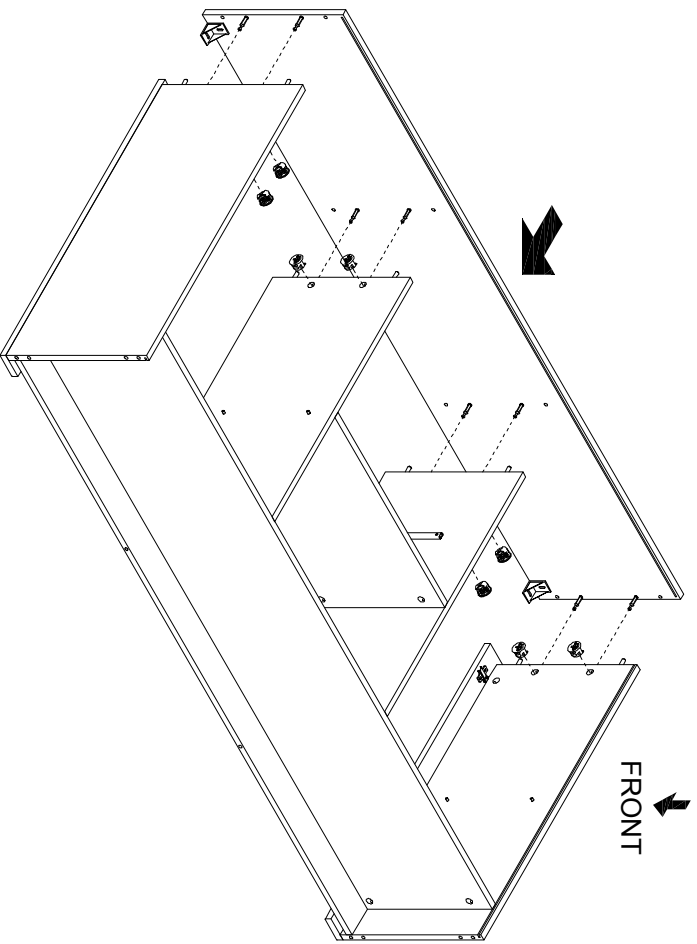
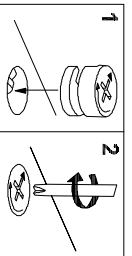

20

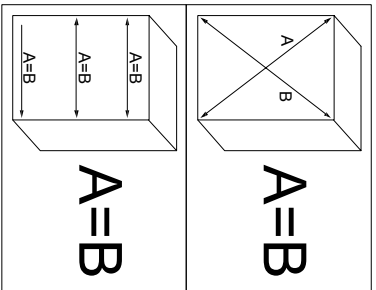

21

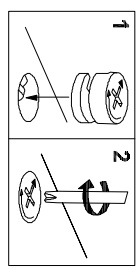
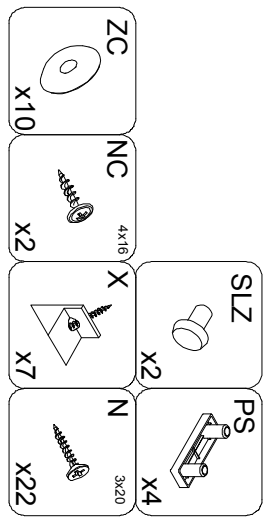
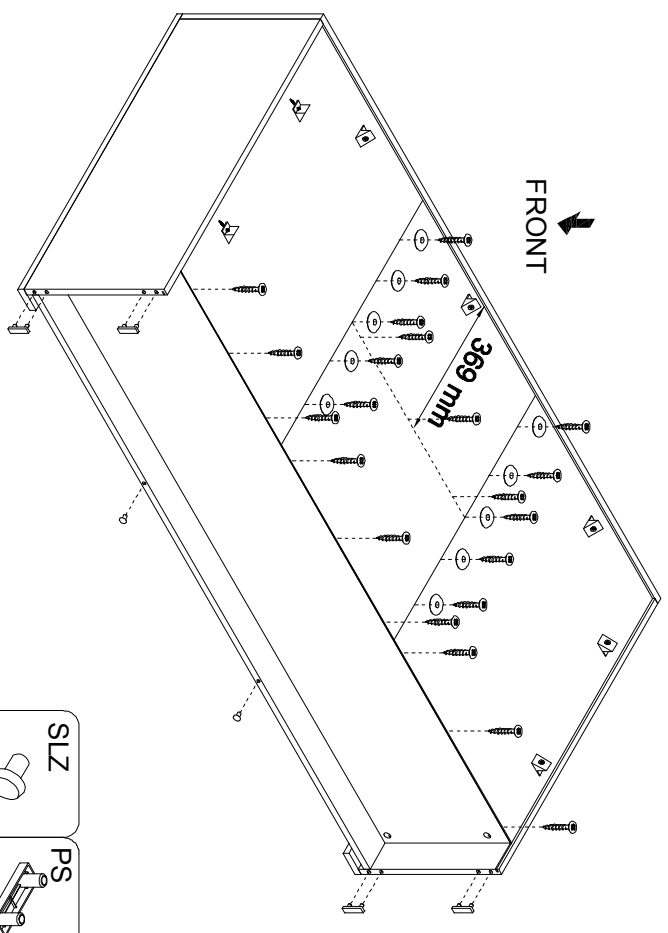
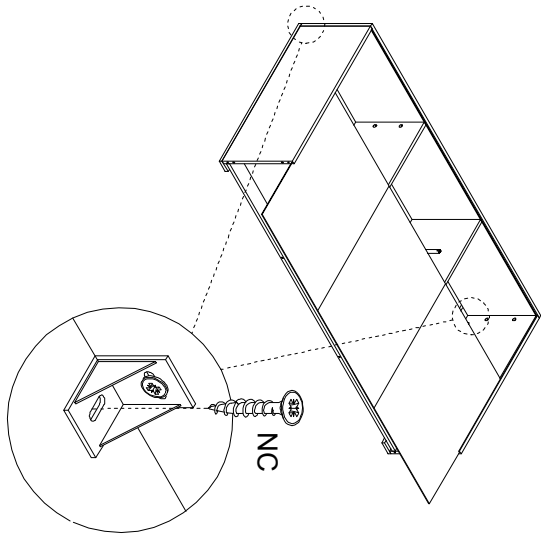

22

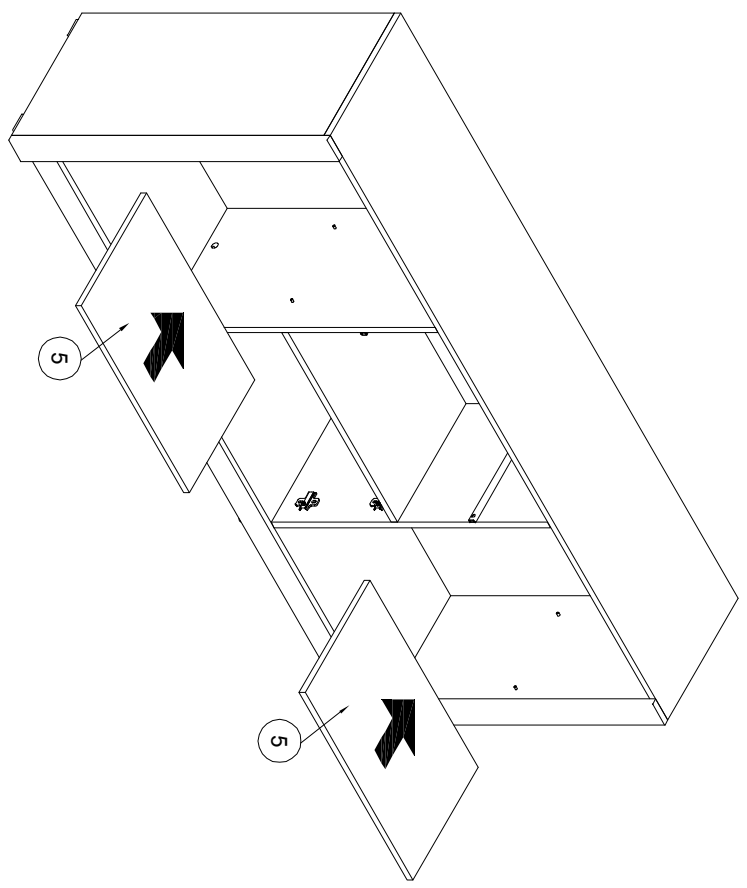

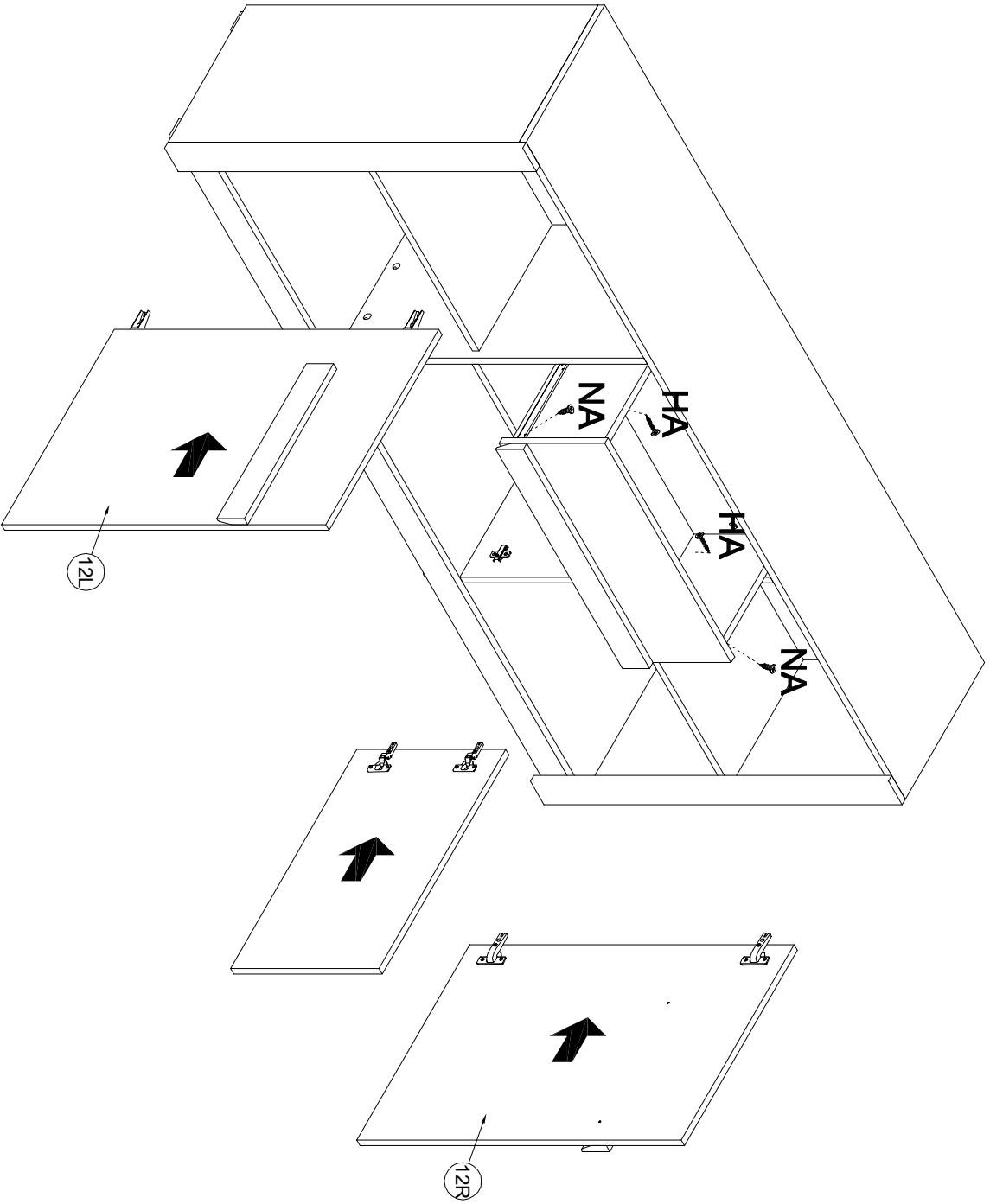
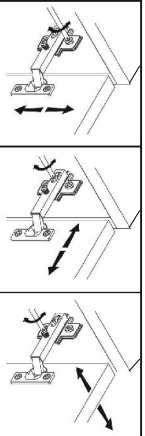

- NA 4x13 x2
- HA MAx20 x2